



Series SB-SS & CS

Seal Welded High Pressure Ball Valves

FEATURES

- Seal Welded Construction
- Available in WCB Carbon Steel with 316SS Trim, or Full CF8M/316Stainless
- 2160WOG Rating on CF8M, 2220WOG on WCB
- Fully Compliant with ASME B16.34 Class 900
- All Models are NACE MR-01-75 Compliant
- All Models are API 607 Fourth Edition Fire Safe
- Fully Compliant with API608
- Standard ISO Actuator Mounting Pads on all Sizes
- Standard Locking Stainless Steel Handles
- The Ultimate Valve for Safe High Pressure Service!



RATINGS

2220 PSIG @100F WATER, OIL, GAS (WCB)
2160 PSIG @100F WATER, OIL, GAS (CF8M)
250 PSIG SAT. STEAM

MATERIALS OF CONSTRUCTION

PART	DESCRIPTION	STANDARD MATERIAL
1	BODY	CF8M or WCB
2	TAILPIECE	CF8M or WCB
3	BALL	ASTM A276 GR. 316 SS
4	STEM	ASTM A276 GR. 316 SS
5	PACKING NUT	ASTM A276 GR. 316 SS
6	SEATS (2)	R-PTFE
7	TAILPIECE SEAL	GRAPHITE
8	THRUST WASHER	PTFE
9	STEM PACKING	GRAPHITE
10	LOCK WASHER	304 SS
11	HANDLE NUT	304 SS
12	HANDLE ASSY.	304 SS
13	NAME PLATE	300 SS

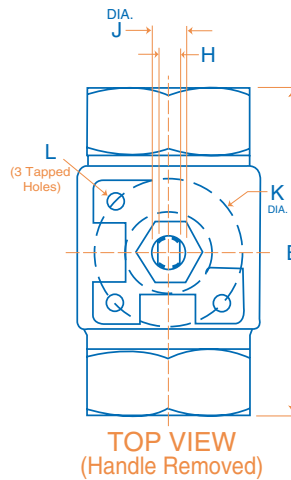
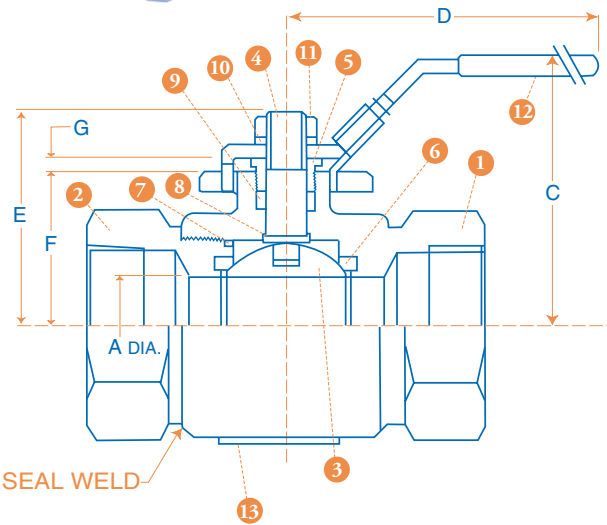

R-PTFE SEATS

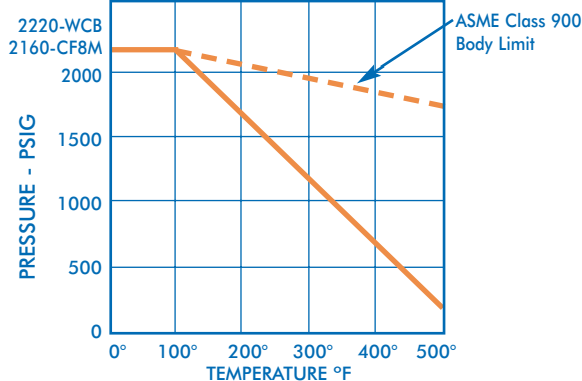

DIMENSIONS, WEIGHTS, CV FACTORS & MAXIMUM OPERATING TORQUE

SIZE	A	B	C	D	E	F	G	H	J	K DIA	L (3 TAPPED HOLES)	ISO PATTERN	WEIGHT LBS.	Cv	MAX. TORQUE (R-PTFE)
1/4"-3/8"	.43	2.65	2.23	5.04	1.53	.78	.35	.20	.31	1.42	1/4"-20 UNC	F03	1.0	10	40 in-lb
1/2"	.43	2.65	2.23	5.04	1.53	.78	.35	.20	.31	1.42	1/4"-20 UNC	F03	1.0	16	75 in-lb
3/4"	.59	3.08	2.72	5.75	2.06	1.03	.43	.28	.44	1.65	1/4"-20 UNC	F04	1.8	27	120 in-lb
1"	.81	3.54	2.87	5.75	2.33	1.34	.40	.28	.44	1.65	1/4"-20 UNC	F04	2.5	42	140 in-lb
1-1/4"	1.00	4.01	3.47	7.36	2.76	1.61	.45	.35	.56	1.97	1/4"-20 UNC	F05	3.9	52	250 in-lb
1-1/2"	1.25	4.26	3.69	7.36	2.98	1.83	.45	.35	.56	1.97	1/4"-20 UNC	F05	5.5	80	350 in-lb
2"	1.50	4.94	3.93	7.36	3.18	2.00	.47	.35	.56	1.97	1/4"-20 UNC	F05	8.5	115	420 in-lb

Quadrant[®] VALVE & ACTUATOR, LLC

SERIES SB-SS & CS REV. 9/03

NUMBERING SYSTEM ... HOW TO ORDER:

SB R S S R G SL TT 100

SERIES	PORT SIZE	BODY MATERIAL	BALL/STEM MAT'L	SEAT MAT'L	SEAL MAT'L	HANDLE TYPE	ENDS	SIZE
SB = SEAL WELDED	R = REDUCED F = FULL (1/4" - 3/8")	S = STAINLESS (ASTM A351-CF8M) C = CARBON (A216-WCB) A = ALLOY20 (A351-CN7M)	S = 316 STAINLESS A = ALLOY 20 H = HASTELLOY	R = R-PTFE P = PEEK	G = GRAPHITE R = R-PTFE	SL = STAINLESS LATCH LOCK SO = STAINLESS OVAL LOCKING STAINLESS OVAL ST = 304SS TEE HANDLE PA = DOUBLE ACTING PNEUMATIC SA = SPRING RETURN PNEUMATIC SR = DEADMAN HANDLE EA = 115VAC ELECTRIC ACTUATED	TT = FNPT MT = MxF NPT	025 = 1/4" 038 = 3/8" 050 = 1/2" 075 = 3/4" 100 = 1" 125 = 1-1/4" 150 = 1-1/2" 200 = 2"

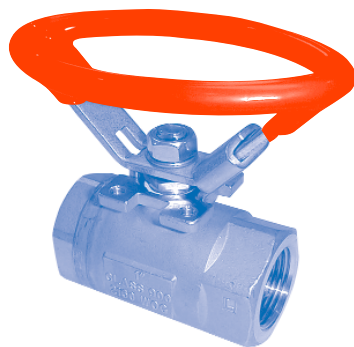

**SB-SS with Locking
304SS Oval Handle**

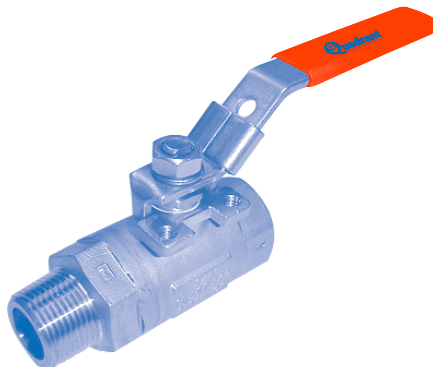

**SB-SS Male NPT
by Female NPT**

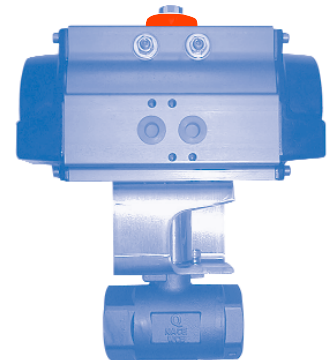

**SB-CS with Quadrant
C-Series Pneumatic Actuator**

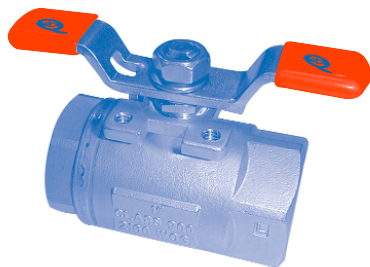

**SB-SS with 304SS
Tee Handle**

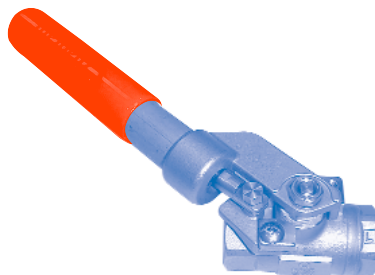

**SB-SS with "Deadman"
Spring Return Handle**



**SB-CS with Quadrant
Electric Actuator**